

March 2025



# LAMINATE WORKSURFACES



# INDEX

Standard Features & Finishes .....	1
Rectangular Worksurfaces .....	2
Rectangular Worksurfaces with One Grommet Hole .....	3
Rectangular Worksurfaces with Two Grommet Holes .....	4
Rectangular Worksurfaces for Height-Adjustable Tables .....	5
Rectangular Worksurfaces for Height-Adjustable Tables with One Grommet Hole .....	5
Square Worksurfaces .....	6
Round Worksurfaces.....	6
Half-Round Worksurfaces .....	6
D-Shaped Worksurfaces .....	7
P-Shaped Worksurfaces .....	8
Bow-Shaped Worksurfaces.....	9
Boat-Shaped Worksurfaces.....	9
Corner Worksurfaces (Equal-Sided).....	10
Extended Corner Worksurfaces .....	11
Transitional Extended Corner Worksurfaces.....	13
120° Worksurfaces.....	13
Reverse Grain Worksurfaces for Returns and Bridges.....	14
Accessories .....	15
High Pressure Laminate Worksurface Warranty .....	17

\*\*\*Stand-alone or small-quantity surface orders may be declined or receive additional skidding and packaging charges – email [sales@metalarcinc.com](mailto:sales@metalarcinc.com) for a quote.\*\*\*

[www.metalarcinc.com](http://www.metalarcinc.com)

3792 E. Ellis Rd.  
Muskegon, MI 49444  
PH: (231) 865-3111  
FAX: (231) 865-2037



## Standard Features & Finishes

Metal Arc worksurfaces feature high-pressure laminate (HPL), 3 mm matching edgebanding, and a nominal height of 1-1/4". For woodgrain laminates, the grain direction will run with the width of the surface unless otherwise specified.

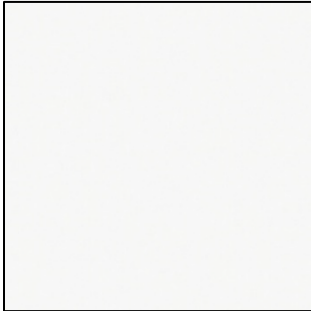

**Brite White**  
Formica 459-58

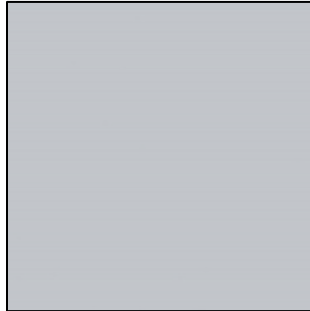

**Zen Grey**  
Formica 9243-58



**Smoke**  
Formica 3245-58



**Charcoal Cerise**  
Formica 8865-58

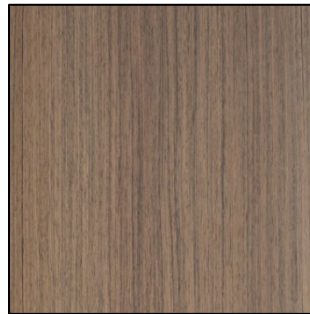

**Gallery Teak**  
Formica 8349-58

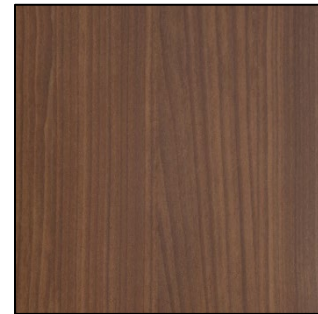

**Brown Cerise**  
Formica 8864-58



**Natural Cerise**  
Formica 8863-58



**Cherry Heartwood**  
Formica 9240-58



**Chelsea Maple**  
Formica 9238-58

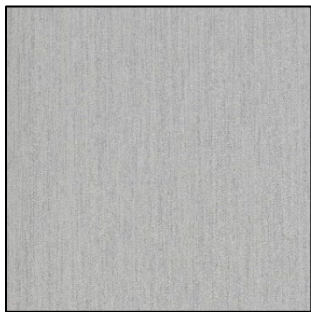

**Silver Alloy**  
Formica 8866-58



**Wood Brushstroke**  
Formica 6998-58



**White Ash**  
Formica 8841-58

## Rectangular Worksurfaces

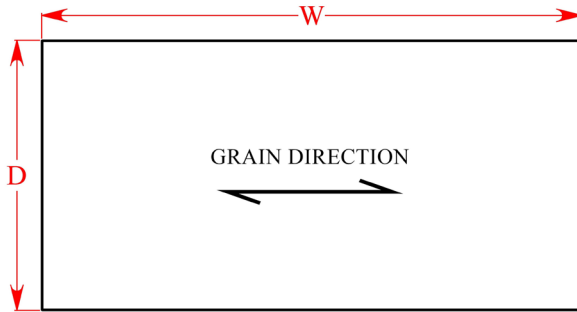

Product No.	D	W	Weight	List Price
WORK-14d24w	14	24	11 lbs	\$186
WORK-14d30w	14	30	13 lbs	\$195
WORK-14d36w	14	36	16 lbs	\$203
WORK-14d42w	14	42	19 lbs	\$207
WORK-14d48w	14	48	21 lbs	\$212
WORK-14d54w	14	54	24 lbs	\$259
WORK-14d60w	14	60	27 lbs	\$264
WORK-14d66w	14	66	30 lbs	\$297
WORK-14d72w	14	72	32 lbs	\$302
WORK-14d78w	14	78	35 lbs	\$414
WORK-14d84w	14	84	38 lbs	\$419
WORK-14d90w	14	90	40 lbs	\$423
WORK-14d96w	14	96	43 lbs	\$428

Product No.	D	W	Weight	List Price
WORK-18d24w	18	24	14 lbs	\$203
WORK-18d30w	18	30	17 lbs	\$212
WORK-18d36w	18	36	21 lbs	\$220
WORK-18d42w	18	42	24 lbs	\$225
WORK-18d48w	18	48	28 lbs	\$230
WORK-18d54w	18	54	31 lbs	\$281
WORK-18d60w	18	60	35 lbs	\$285
WORK-18d66w	18	66	38 lbs	\$321
WORK-18d72w	18	72	41 lbs	\$326
WORK-18d78w	18	78	45 lbs	\$447
WORK-18d84w	18	84	48 lbs	\$452
WORK-18d90w	18	90	52 lbs	\$456
WORK-18d96w	18	96	55 lbs	\$461

Product No.	D	W	Weight	List Price
WORK-24d30w	24	30	23 lbs	\$239
WORK-24d36w	24	36	28 lbs	\$248
WORK-24d42w	24	42	32 lbs	\$252
WORK-24d48w	24	48	37 lbs	\$257
WORK-24d54w	24	54	41 lbs	\$314
WORK-24d60w	24	60	46 lbs	\$319
WORK-24d66w	24	66	51 lbs	\$376
WORK-24d72w	24	72	55 lbs	\$381
WORK-24d78w	24	78	60 lbs	\$530
WORK-24d84w	24	84	64 lbs	\$540
WORK-24d90w	24	90	69 lbs	\$548
WORK-24d96w	24	96	74 lbs	\$557

Product No.	D	W	Weight	List Price
WORK-30d36w	30	36	35 lbs	\$309
WORK-30d42w	30	42	40 lbs	\$314
WORK-30d48w	30	48	46 lbs	\$319
WORK-30d54w	30	54	52 lbs	\$394
WORK-30d60w	30	60	58 lbs	\$398
WORK-30d66w	30	66	63 lbs	\$469
WORK-30d72w	30	72	69 lbs	\$473
WORK-30d78w	30	78	75 lbs	\$649
WORK-30d84w	30	84	81 lbs	\$657
WORK-30d90w	30	90	86 lbs	\$665
WORK-30d96w	30	96	92 lbs	\$673

Product No.	D	W	Weight	List Price
WORK-36d42w	36	42	48 lbs	\$404
WORK-36d48w	36	48	55 lbs	\$409
WORK-36d54w	36	54	62 lbs	\$487
WORK-36d60w	36	60	69 lbs	\$492
WORK-36d66w	36	66	76 lbs	\$588
WORK-36d72w	36	72	83 lbs	\$593
WORK-36d78w	36	78	90 lbs	\$811
WORK-36d84w	36	84	97 lbs	\$819
WORK-36d90w	36	90	104 lbs	\$827
WORK-36d96w	36	96	110 lbs	\$891

## Rectangular Worksurfaces with One Grommet Hole

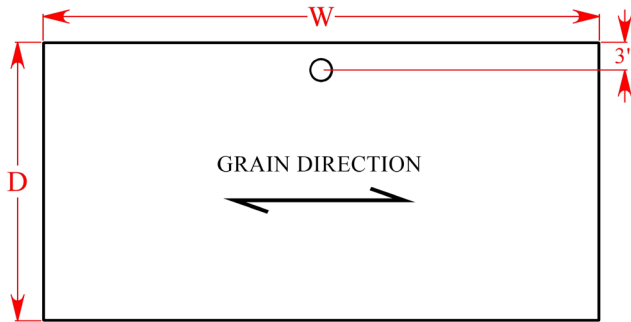

Grommet hole is centered from left-to-right

Grommet sold separately – see page 16

Product No.	D	W	Weight	List Price
WORK-G1-18d24w	18	24	14 lbs	\$223
WORK-G1-18d30w	18	30	17 lbs	\$232
WORK-G1-18d36w	18	36	21 lbs	\$240
WORK-G1-18d42w	18	42	24 lbs	\$245
WORK-G1-18d48w	18	48	28 lbs	\$250
WORK-G1-18d54w	18	54	31 lbs	\$301
WORK-G1-18d60w	18	60	35 lbs	\$305
WORK-G1-18d66w	18	66	38 lbs	\$341
WORK-G1-18d72w	18	72	41 lbs	\$346
WORK-G1-18d78w	18	78	45 lbs	\$467
WORK-G1-18d84w	18	84	48 lbs	\$472
WORK-G1-18d90w	18	90	52 lbs	\$476
WORK-G1-18d96w	18	96	55 lbs	\$481

Product No.	D	W	Weight	List Price
WORK-G1-24d30w	24	30	23 lbs	\$259
WORK-G1-24d36w	24	36	28 lbs	\$268
WORK-G1-24d42w	24	42	32 lbs	\$272
WORK-G1-24d48w	24	48	37 lbs	\$277
WORK-G1-24d54w	24	54	41 lbs	\$334
WORK-G1-24d60w	24	60	46 lbs	\$339
WORK-G1-24d66w	24	66	51 lbs	\$396
WORK-G1-24d72w	24	72	55 lbs	\$401
WORK-G1-24d78w	24	78	60 lbs	\$550
WORK-G1-24d84w	24	84	64 lbs	\$560
WORK-G1-24d90w	24	90	69 lbs	\$568
WORK-G1-24d96w	24	96	74 lbs	\$577

Product No.	D	W	Weight	List Price
WORK-G1-30d36w	30	36	35 lbs	\$329
WORK-G1-30d42w	30	42	40 lbs	\$334
WORK-G1-30d48w	30	48	46 lbs	\$339
WORK-G1-30d54w	30	54	52 lbs	\$414
WORK-G1-30d60w	30	60	58 lbs	\$418
WORK-G1-30d66w	30	66	63 lbs	\$489
WORK-G1-30d72w	30	72	69 lbs	\$493
WORK-G1-30d78w	30	78	75 lbs	\$669
WORK-G1-30d84w	30	84	81 lbs	\$677
WORK-G1-30d90w	30	90	86 lbs	\$685
WORK-G1-30d96w	30	96	92 lbs	\$693

Product No.	D	W	Weight	List Price
WORK-G1-36d42w	36	42	48 lbs	\$424
WORK-G1-36d48w	36	48	55 lbs	\$429
WORK-G1-36d54w	36	54	62 lbs	\$507
WORK-G1-36d60w	36	60	69 lbs	\$512
WORK-G1-36d66w	36	66	76 lbs	\$608
WORK-G1-36d72w	36	72	83 lbs	\$613
WORK-G1-36d78w	36	78	90 lbs	\$831
WORK-G1-36d84w	36	84	97 lbs	\$839
WORK-G1-36d90w	36	90	104 lbs	\$847
WORK-G1-36d96w	36	96	110 lbs	\$911

## Rectangular Worksurfaces with Two Grommet Holes

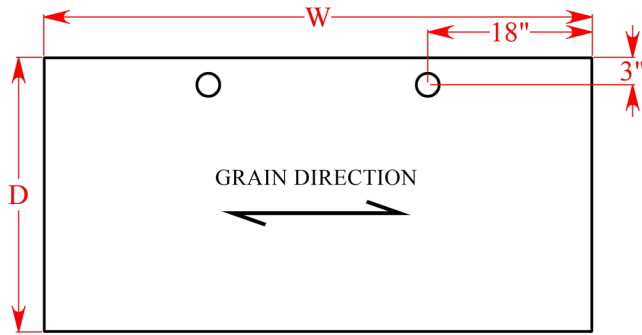

Grommets sold separately – see page 16

Product No.	D	W	Weight	List Price
WORK-G2-18d60w	18	60	35 lbs	\$325
WORK-G2-18d66w	18	66	38 lbs	\$361
WORK-G2-18d72w	18	72	41 lbs	\$366
WORK-G2-18d78w	18	78	45 lbs	\$487
WORK-G2-18d84w	18	84	48 lbs	\$492
WORK-G2-18d90w	18	90	52 lbs	\$496
WORK-G2-18d96w	18	96	55 lbs	\$501

Product No.	D	W	Weight	List Price
WORK-G2-24d60w	24	60	46 lbs	\$359
WORK-G2-24d66w	24	66	51 lbs	\$416
WORK-G2-24d72w	24	72	55 lbs	\$421
WORK-G2-24d78w	24	78	60 lbs	\$570
WORK-G2-24d84w	24	84	64 lbs	\$580
WORK-G2-24d90w	24	90	69 lbs	\$588
WORK-G2-24d96w	24	96	74 lbs	\$597

Product No.	D	W	Weight	List Price
WORK-G2-30d60w	30	60	58 lbs	\$438
WORK-G2-30d66w	30	66	63 lbs	\$509
WORK-G2-30d72w	30	72	69 lbs	\$513
WORK-G2-30d78w	30	78	75 lbs	\$689
WORK-G2-30d84w	30	84	81 lbs	\$697
WORK-G2-30d90w	30	90	86 lbs	\$705
WORK-G2-30d96w	30	96	92 lbs	\$713

Product No.	D	W	Weight	List Price
WORK-G2-36d60w	36	60	69 lbs	\$532
WORK-G2-36d66w	36	66	76 lbs	\$628
WORK-G2-36d72w	36	72	83 lbs	\$633
WORK-G2-36d78w	36	78	90 lbs	\$851
WORK-G2-36d84w	36	84	97 lbs	\$859
WORK-G2-36d90w	36	90	104 lbs	\$867
WORK-G2-36d96w	36	96	110 lbs	\$931

## Rectangular Worksurfaces for Height-Adjustable Tables

Rectangular worksurfaces for height-adjustable tables are 1” shallower in depth and 2” narrower in width compared to standard worksurfaces. They are used to minimize the risk of pinch points when height-adjustable tables are aligned next to each other or used within a panel system.

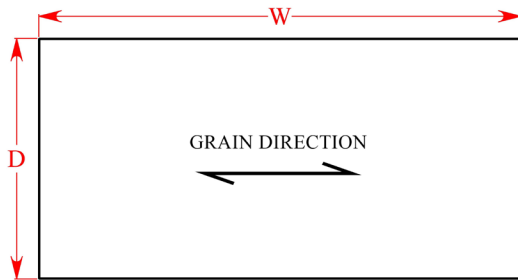

Product No.	D	W	Weight	List Price
WORK-HAT-23d46w	23	46	34 lbs	\$254
WORK-HAT-23d52w	23	52	38 lbs	\$311
WORK-HAT-23d58w	23	58	43 lbs	\$316
WORK-HAT-23d64w	23	64	47 lbs	\$373
WORK-HAT-23d70w	23	70	51 lbs	\$378
WORK-HAT-23d76w	23	76	56 lbs	\$527
WORK-HAT-23d82w	23	82	60 lbs	\$537

Product No.	D	W	Weight	List Price
WORK-HAT-29d46w	29	46	43 lbs	\$316
WORK-HAT-29d52w	29	52	48 lbs	\$391
WORK-HAT-29d58w	29	58	54 lbs	\$395
WORK-HAT-29d64w	29	64	59 lbs	\$466
WORK-HAT-29d70w	29	70	65 lbs	\$470
WORK-HAT-29d76w	29	76	70 lbs	\$646
WORK-HAT-29d82w	29	82	76 lbs	\$654

## Rectangular Worksurfaces for Height-Adjustable Tables with One Grommet Hole

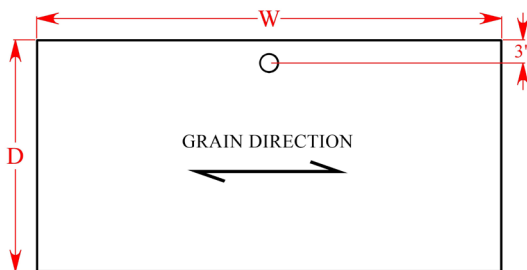

Grommet hole is centered from left-to-right

Grommet sold separately – see page 16

Product No.	D	W	Weight	List Price
WORK-HAT-G1-23d46w	23	46	34 lbs	\$274
WORK-HAT-G1-23d52w	23	52	38 lbs	\$331
WORK-HAT-G1-23d58w	23	58	43 lbs	\$336
WORK-HAT-G1-23d64w	23	64	47 lbs	\$393
WORK-HAT-G1-23d70w	23	70	51 lbs	\$398
WORK-HAT-G1-23d76w	23	76	56 lbs	\$547
WORK-HAT-G1-23d82w	23	82	60 lbs	\$557

Product No.	D	W	Weight	List Price
WORK-HAT-G1-29d46w	29	46	43 lbs	\$336
WORK-HAT-G1-29d52w	29	52	48 lbs	\$411
WORK-HAT-G1-29d58w	29	58	54 lbs	\$415
WORK-HAT-G1-29d64w	29	64	59 lbs	\$486
WORK-HAT-G1-29d70w	29	70	65 lbs	\$490
WORK-HAT-G1-29d76w	29	76	70 lbs	\$666
WORK-HAT-G1-29d82w	29	82	76 lbs	\$674

## Square Worksurfaces

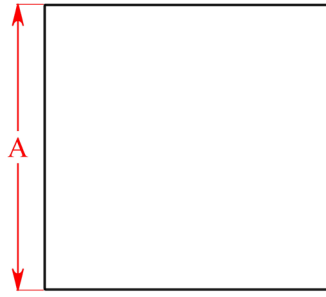

Product No.	A	Weight	List Price
WORK-SQ-18	18	10 lbs	\$186
WORK-SQ-24	24	18 lbs	\$191
WORK-SQ-30	30	29 lbs	\$244
WORK-SQ-36	36	41 lbs	\$330
WORK-SQ-42	42	56 lbs	\$456
WORK-SQ-46	46	68 lbs	\$481

## Round Worksurfaces

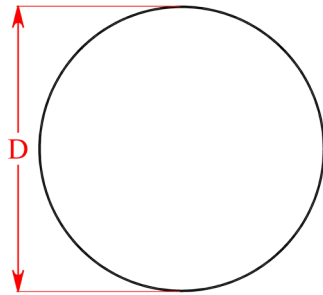

Product No.	Diameter	Weight	List Price
WORK-RD-18	18	8 lbs	\$224
WORK-RD-24	24	14 lbs	\$229
WORK-RD-30	30	23 lbs	\$289
WORK-RD-36	36	32 lbs	\$375
WORK-RD-42	42	44 lbs	\$508
WORK-RD-46	46	53 lbs	\$533

## Half-Round Worksurfaces

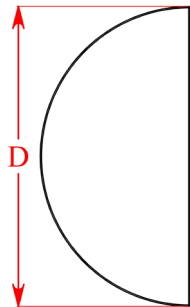

Product No.	Diameter	Weight	List Price
WORK-RDH-30	30	11 lbs	\$334
WORK-RDH-36	36	16 lbs	\$345
WORK-RDH-42	42	22 lbs	\$373
WORK-RDH-48	48	29 lbs	\$382
WORK-RDH-54	54	37 lbs	\$514
WORK-RDH-60	60	45 lbs	\$523



## D-Shaped Worksurfaces

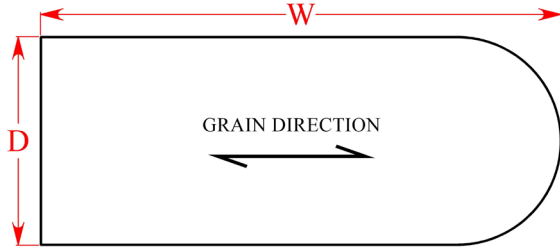

Product No.	D	W	Weight	List Price
WORK-D-24d30w	24	30	20 lbs	\$364
WORK-D-24d36w	24	36	23 lbs	\$373
WORK-D-24d42w	24	42	29 lbs	\$377
WORK-D-24d48w	24	48	33 lbs	\$382
WORK-D-24d54w	24	54	39 lbs	\$439
WORK-D-24d60w	24	60	44 lbs	\$444
WORK-D-24d66w	24	66	48 lbs	\$501
WORK-D-24d72w	24	72	52 lbs	\$506
WORK-D-24d78w	24	78	57 lbs	\$655
WORK-D-24d84w	24	84	62 lbs	\$665
WORK-D-24d90w	24	90	67 lbs	\$673
WORK-D-24d96w	24	96	71 lbs	\$682

Product No.	D	W	Weight	List Price
WORK-D-30d36w	30	36	29 lbs	\$434
WORK-D-30d42w	30	42	34 lbs	\$439
WORK-D-30d48w	30	48	41 lbs	\$444
WORK-D-30d54w	30	54	47 lbs	\$519
WORK-D-30d60w	30	60	55 lbs	\$523
WORK-D-30d66w	30	66	60 lbs	\$594
WORK-D-30d72w	30	72	66 lbs	\$598
WORK-D-30d78w	30	78	71 lbs	\$774
WORK-D-30d84w	30	84	78 lbs	\$782
WORK-D-30d90w	30	90	84 lbs	\$790
WORK-D-30d96w	30	96	89 lbs	\$798

Product No.	D	W	Weight	List Price
WORK-D-36d42w	36	42	41 lbs	\$529
WORK-D-36d48w	36	48	50 lbs	\$534
WORK-D-36d54w	36	54	56 lbs	\$612
WORK-D-36d60w	36	60	66 lbs	\$617
WORK-D-36d66w	36	66	72 lbs	\$713
WORK-D-36d72w	36	72	79 lbs	\$718
WORK-D-36d78w	36	78	85 lbs	\$936
WORK-D-36d84w	36	84	94 lbs	\$944
WORK-D-36d90w	36	90	100 lbs	\$952
WORK-D-36d96w	36	96	107 lbs	\$1,016

Product No.	D	W	Weight	List Price
WORK-D-42d48w	42	48	58 lbs	\$614
WORK-D-42d54w	42	54	65 lbs	\$728
WORK-D-42d60w	42	60	76 lbs	\$738
WORK-D-42d66w	42	66	84 lbs	\$852
WORK-D-42d72w	42	72	92 lbs	\$862
WORK-D-42d78w	42	78	99 lbs	\$1,160
WORK-D-42d84w	42	84	109 lbs	\$1,180
WORK-D-42d90w	42	90	117 lbs	\$1,196
WORK-D-42d96w	42	96	125 lbs	\$1,214

Product No.	D	W	Weight	List Price
WORK-D-46d54w	46	54	71 lbs	\$778
WORK-D-46d60w	46	60	84 lbs	\$788
WORK-D-46d66w	46	66	92 lbs	\$902
WORK-D-46d72w	46	72	101 lbs	\$912
WORK-D-46d78w	46	78	109 lbs	\$1,210
WORK-D-46d84w	46	84	120 lbs	\$1,230
WORK-D-46d90w	46	90	128 lbs	\$1,246
WORK-D-46d96w	46	96	137 lbs	\$1,264

## P-Shaped Worksurfaces

### 24" Deep P-Tops (30" Overall Depth)

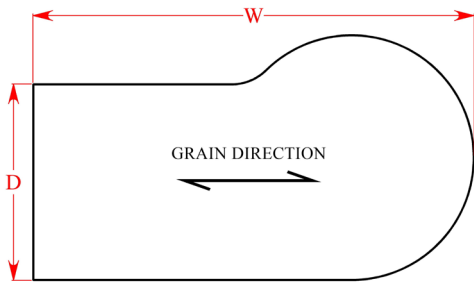
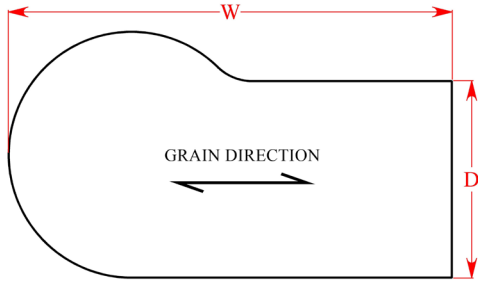

Product No.	D	W	Weight	List Price
WORK-P-24d54w-LFT	24	54	46 lbs	\$529
WORK-P-24d60w-LFT	24	60	54 lbs	\$533
WORK-P-24d66w-LFT	24	66	58 lbs	\$604
WORK-P-24d72w-LFT	24	72	64 lbs	\$608
WORK-P-24d78w-LFT	24	78	68 lbs	\$784
WORK-P-24d84w-LFT	24	84	75 lbs	\$792
WORK-P-24d90w-LFT	24	90	80 lbs	\$800
WORK-P-24d96w-LFT	24	96	85 lbs	\$808

Product No.	D	W	Weight	List Price
WORK-P-24d54w-RGT	24	54	46 lbs	\$529
WORK-P-24d60w-RGT	24	60	54 lbs	\$533
WORK-P-24d66w-RGT	24	66	58 lbs	\$604
WORK-P-24d72w-RGT	24	72	64 lbs	\$608
WORK-P-24d78w-RGT	24	78	68 lbs	\$784
WORK-P-24d84w-RGT	24	84	75 lbs	\$792
WORK-P-24d90w-RGT	24	90	80 lbs	\$800
WORK-P-24d96w-RGT	24	96	85 lbs	\$808

### 30" Deep P-Tops (36" Overall Depth)

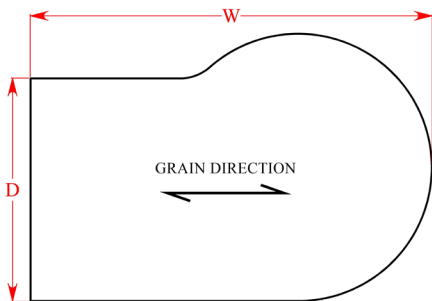
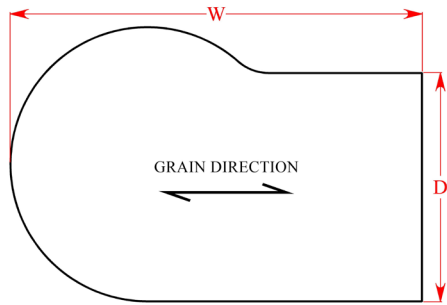

Product No.	D	W	Weight	List Price
WORK-P-30d54w-LFT	30	54	55 lbs	\$622
WORK-P-30d60w-LFT	30	60	65 lbs	\$627
WORK-P-30d66w-LFT	30	66	70 lbs	\$723
WORK-P-30d72w-LFT	30	72	77 lbs	\$728
WORK-P-30d78w-LFT	30	78	82 lbs	\$946
WORK-P-30d84w-LFT	30	84	91 lbs	\$954
WORK-P-30d90w-LFT	30	90	96 lbs	\$962
WORK-P-30d96w-LFT	30	96	103 lbs	\$1,026

Product No.	D	W	Weight	List Price
WORK-P-30d54w-RGT	30	54	55 lbs	\$622
WORK-P-30d60w-RGT	30	60	65 lbs	\$627
WORK-P-30d66w-RGT	30	66	70 lbs	\$723
WORK-P-30d72w-RGT	30	72	77 lbs	\$728
WORK-P-30d78w-RGT	30	78	82 lbs	\$946
WORK-P-30d84w-RGT	30	84	91 lbs	\$954
WORK-P-30d90w-RGT	30	90	96 lbs	\$962
WORK-P-30d96w-RGT	30	96	103 lbs	\$1,026

## Bow-Shaped Worksurfaces

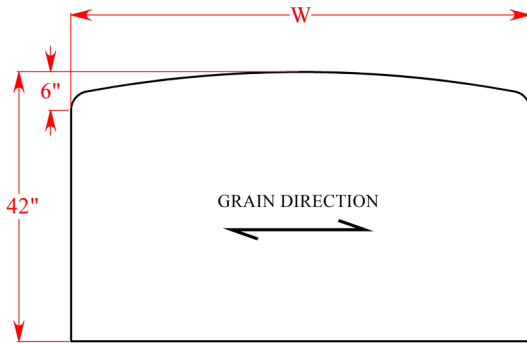
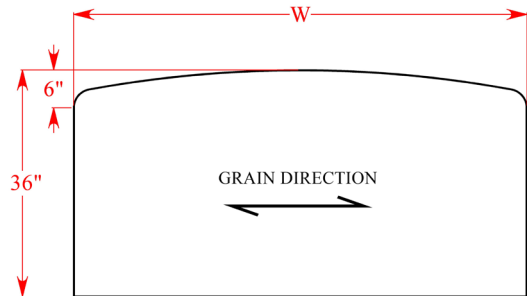
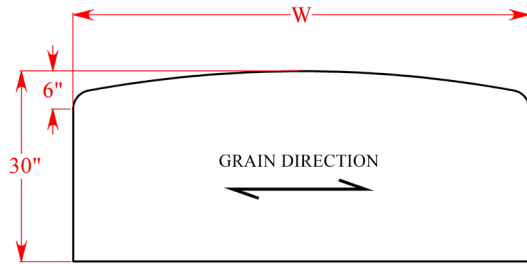

Product No.	D	W	Weight	List Price
WORK-BOW-30d60w	30	60	55 lbs	\$523
WORK-BOW-30d66w	30	66	60 lbs	\$594
WORK-BOW-30d72w	30	72	66 lbs	\$598
WORK-BOW-30d78w	30	78	71 lbs	\$774
WORK-BOW-30d84w	30	84	76 lbs	\$782
WORK-BOW-30d90w	30	90	82 lbs	\$790
WORK-BOW-30d96w	30	96	87 lbs	\$798

Product No.	D	W	Weight	List Price
WORK-BOW-36d60w	36	60	66 lbs	\$617
WORK-BOW-36d66w	36	66	72 lbs	\$713
WORK-BOW-36d72w	36	72	79 lbs	\$718
WORK-BOW-36d78w	36	78	85 lbs	\$936
WORK-BOW-36d84w	36	84	92 lbs	\$944
WORK-BOW-36d90w	36	90	98 lbs	\$952
WORK-BOW-36d96w	36	96	105 lbs	\$1,016

Product No.	D	W	Weight	List Price
WORK-BOW-42d60w	42	60	76 lbs	\$738
WORK-BOW-42d66w	42	66	84 lbs	\$852
WORK-BOW-42d72w	42	72	92 lbs	\$862
WORK-BOW-42d78w	42	78	99 lbs	\$1,160
WORK-BOW-42d84w	42	84	107 lbs	\$1,180
WORK-BOW-42d90w	42	90	115 lbs	\$1,096
WORK-BOW-42d96w	42	96	123 lbs	\$1,214

## Boat-Shaped Worksurfaces

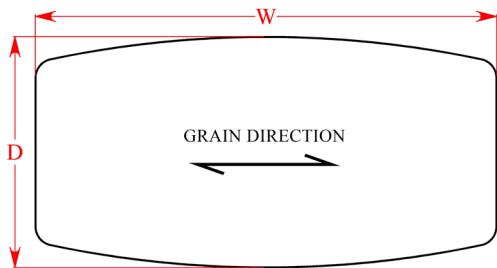

Product No.	D	W	Weight	List Price
WORK-BOAT-36d72w	36	72	79 lbs	\$793
WORK-BOAT-36d78w	36	78	85 lbs	\$1,011
WORK-BOAT-36d84w	36	84	92 lbs	\$1,019
WORK-BOAT-36d90w	36	90	98 lbs	\$1,027
WORK-BOAT-36d96w	36	96	105 lbs	\$1,091

Product No.	D	W	Weight	List Price
WORK-BOAT-42d72w	42	72	92 lbs	\$937
WORK-BOAT-42d78w	42	78	99 lbs	\$1,235
WORK-BOAT-42d84w	42	84	107 lbs	\$1,255
WORK-BOAT-42d90w	42	90	115 lbs	\$1,271
WORK-BOAT-42d96w	42	96	122 lbs	\$1,289

Product No.	D	W	Weight	List Price
WORK-BOAT-46d72w	46	72	101 lbs	\$987
WORK-BOAT-46d78w	46	78	109 lbs	\$1,285
WORK-BOAT-46d84w	46	84	117 lbs	\$1,305
WORK-BOAT-46d90w	46	90	126 lbs	\$1,321
WORK-BOAT-46d96w	46	96	134 lbs	\$1,339

## Corner Worksurfaces (Equal-Sided)

### 45° Grain

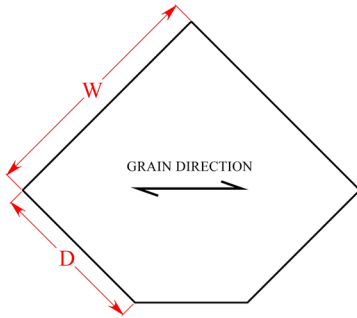

Product No.	D	W	Weight	List Price
WORK-C-24d36w	24	36	26 lbs	\$500
WORK-C-24d42w	24	42	30 lbs	\$633
WORK-C-30d42w	30	42	38 lbs	\$686

### 45° Grain with Center Hole (Grommet sold separately – see page 16)

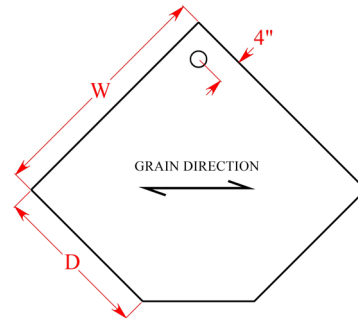

Product No.	D	W	Weight	List Price
WORK-C-G1-24d36w	24	36	26 lbs	\$520
WORK-C-G1-24d42w	24	42	30 lbs	\$653
WORK-C-G1-30d42w	30	42	38 lbs	\$706

### Left-to-Right Grain

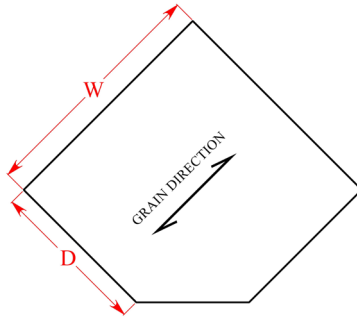

Product No.	D	W	Weight	List Price
WORK-CA-24d36w	24	36	26 lbs	\$480
WORK-CA-24d42w	24	42	30 lbs	\$606
WORK-CA-30d42w	30	42	38 lbs	\$616

### Left-to-Right Grain with Center Hole

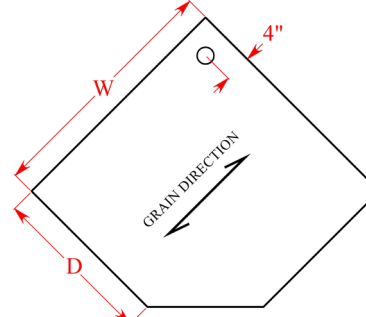

Product No.	D	W	Weight	List Price
WORK-CA-G1-24d36w	24	36	26 lbs	\$500
WORK-CA-G1-24d42w	24	42	30 lbs	\$626
WORK-CA-G1-30d42w	30	42	38 lbs	\$636

### Right-to-Left Grain

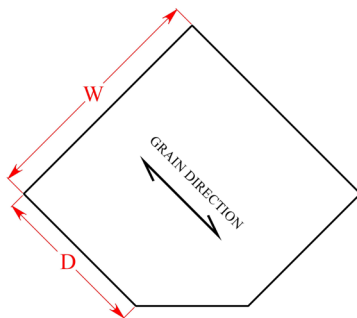

Product No.	D	W	Weight	List Price
WORK-CB-24d36w	24	36	26 lbs	\$480
WORK-CB-24d42w	24	42	30 lbs	\$606
WORK-CB-30d42w	30	42	38 lbs	\$616

### Right-to-Left Grain with Center Hole

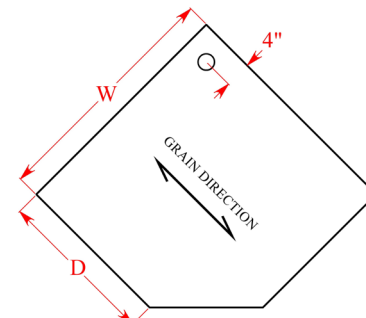

Product No.	D	W	Weight	List Price
WORK-CB-G1-24d36w	24	36	26 lbs	\$500
WORK-CB-G1-24d42w	24	42	30 lbs	\$626
WORK-CB-G1-30d42w	30	42	38 lbs	\$636

# Extended Corner Worksurfaces

## Surfaces with 24” Ends

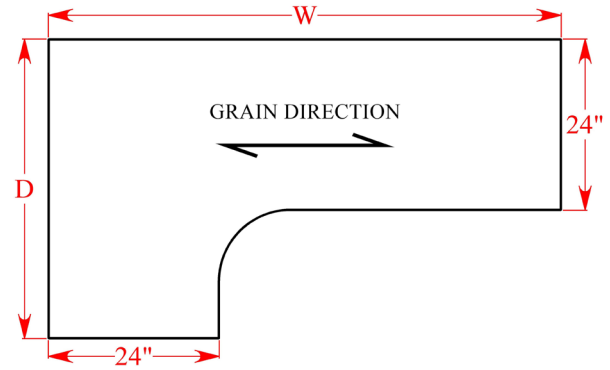
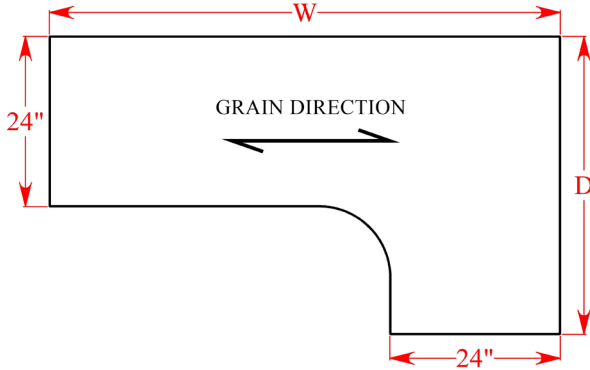

Product No.	D	W	Weight	List Price
WORK-EC24-36d54w-LFT	36	54	53 lbs	\$662
WORK-EC24-36d60w-LFT	36	60	58 lbs	\$667
WORK-EC24-36d66w-LFT	36	66	62 lbs	\$763
WORK-EC24-36d72w-LFT	36	72	67 lbs	\$768
WORK-EC24-36d78w-LFT	36	78	71 lbs	\$986
WORK-EC24-36d84w-LFT	36	84	76 lbs	\$994
WORK-EC24-36d90w-LFT	36	90	81 lbs	\$1,002
WORK-EC24-36d96w-LFT	36	96	85 lbs	\$1,066

Product No.	D	W	Weight	List Price
WORK-EC24-36d54w-RGT	36	54	53 lbs	\$662
WORK-EC24-36d60w-RGT	36	60	58 lbs	\$667
WORK-EC24-36d66w-RGT	36	66	62 lbs	\$763
WORK-EC24-36d72w-RGT	36	72	67 lbs	\$768
WORK-EC24-36d78w-RGT	36	78	71 lbs	\$986
WORK-EC24-36d84w-RGT	36	84	76 lbs	\$994
WORK-EC24-36d90w-RGT	36	90	81 lbs	\$1,002
WORK-EC24-36d96w-RGT	36	96	85 lbs	\$1,066

WORK-EC24-42d54w-LFT	42	54	59 lbs	\$778
WORK-EC24-42d60w-LFT	42	60	63 lbs	\$788
WORK-EC24-42d66w-LFT	42	66	68 lbs	\$902
WORK-EC24-42d72w-LFT	42	72	72 lbs	\$912
WORK-EC24-42d78w-LFT	42	78	77 lbs	\$1,210
WORK-EC24-42d84w-LFT	42	84	82 lbs	\$1,230
WORK-EC24-42d90w-LFT	42	90	86 lbs	\$1,246
WORK-EC24-42d96w-LFT	42	96	91 lbs	\$1,264

WORK-EC24-42d54w-RGT	42	54	59 lbs	\$778
WORK-EC24-42d60w-RGT	42	60	63 lbs	\$788
WORK-EC24-42d66w-RGT	42	66	68 lbs	\$902
WORK-EC24-42d72w-RGT	42	72	72 lbs	\$912
WORK-EC24-42d78w-RGT	42	78	77 lbs	\$1,210
WORK-EC24-42d84w-RGT	42	84	82 lbs	\$1,230
WORK-EC24-42d90w-RGT	42	90	86 lbs	\$1,246
WORK-EC24-42d96w-RGT	42	96	91 lbs	\$1,264

### Surfaces with 30” Ends

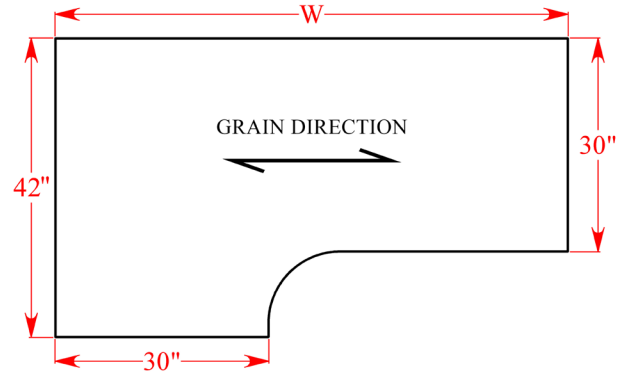
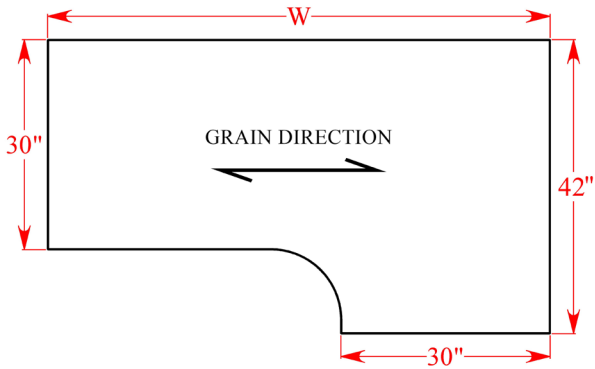

Product No.	D	W	Weight	List Price
WORK-EC30-42d54w-LFT	42	54	66 lbs	\$788
WORK-EC30-42d60w-LFT	42	60	71 lbs	\$798
WORK-EC30-42d66w-LFT	42	66	77 lbs	\$912
WORK-EC30-42d72w-LFT	42	72	83 lbs	\$922
WORK-EC30-42d78w-LFT	42	78	89 lbs	\$1,220
WORK-EC30-42d84w-LFT	42	84	94 lbs	\$1,240
WORK-EC30-42d90w-LFT	42	90	100 lbs	\$1,256
WORK-EC30-42d96w-LFT	42	96	106 lbs	\$1,274

Product No.	D	W	Weight	List Price
WORK-EC30-42d54w-RGT	42	54	66 lbs	\$788
WORK-EC30-42d60w-RGT	42	60	71 lbs	\$798
WORK-EC30-42d66w-RGT	42	66	77 lbs	\$912
WORK-EC30-42d72w-RGT	42	72	83 lbs	\$922
WORK-EC30-42d78w-RGT	42	78	89 lbs	\$1,220
WORK-EC30-42d84w-RGT	42	84	94 lbs	\$1,240
WORK-EC30-42d90w-RGT	42	90	100 lbs	\$1,256
WORK-EC30-42d96w-RGT	42	96	106 lbs	\$1,274

## Transitional Extended Corner Worksurfaces

These special corner worksurfaces have 30” deep ends on the long (extended) surface and 24” deep ends on the short return. The overall depth is always 42” as shown below.

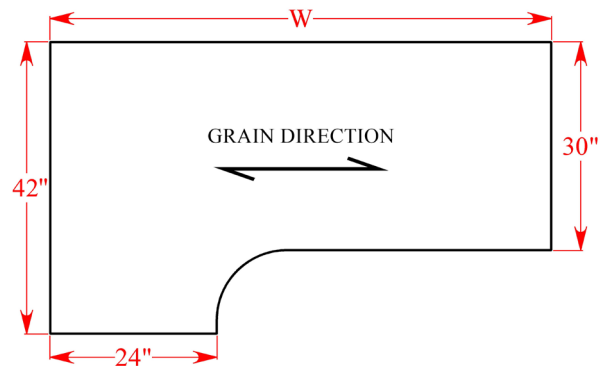
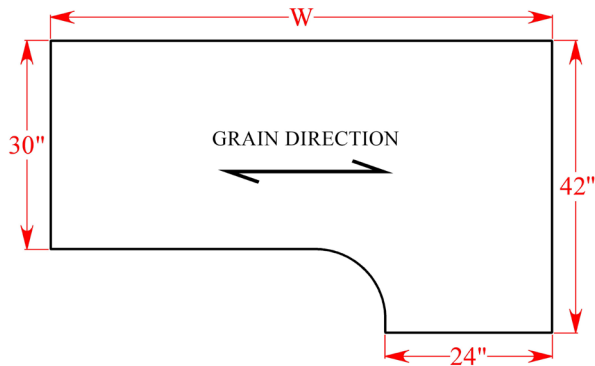

Product No.	D	W	Weight	List Price
WORK-TC3024-42d54w-LFT	42	54	63 lbs	\$798
WORK-TC3024-42d60w-LFT	42	60	69 lbs	\$808
WORK-TC3024-42d66w-LFT	42	66	75 lbs	\$922
WORK-TC3024-42d72w-LFT	42	72	81 lbs	\$932
WORK-TC3024-42d78w-LFT	42	78	86 lbs	\$1,230
WORK-TC3024-42d84w-LFT	42	84	92 lbs	\$1,250
WORK-TC3024-42d90w-LFT	42	90	98 lbs	\$1,266
WORK-TC3024-42d96w-LFT	42	96	104 lbs	\$1,284

Product No.	D	W	Weight	List Price
WORK-TC3024-42d54w-RGT	42	54	63 lbs	\$798
WORK-TC3024-42d60w-RGT	42	60	69 lbs	\$808
WORK-TC3024-42d66w-RGT	42	66	75 lbs	\$922
WORK-TC3024-42d72w-RGT	42	72	81 lbs	\$932
WORK-TC3024-42d78w-RGT	42	78	86 lbs	\$1,230
WORK-TC3024-42d84w-RGT	42	84	92 lbs	\$1,250
WORK-TC3024-42d90w-RGT	42	90	98 lbs	\$1,266
WORK-TC3024-42d96w-RGT	42	96	104 lbs	\$1,284

## 120° Worksurfaces

### Standard

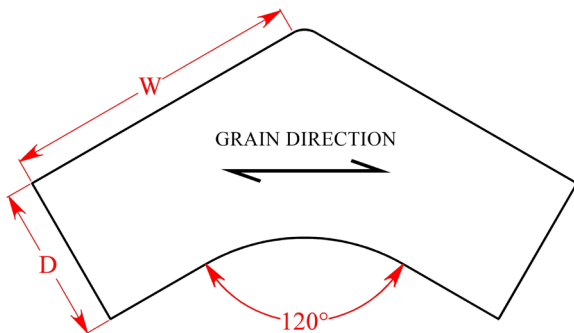

### With Center Hole for Grommet

(Grommet sold separately – see page 16)

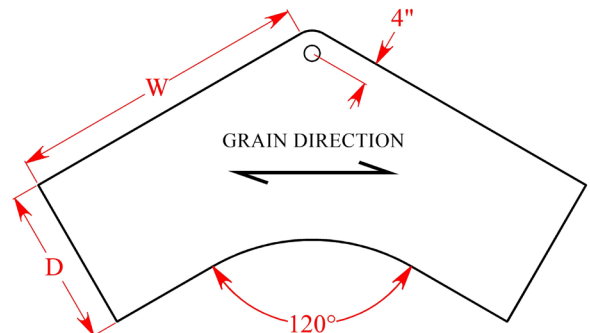

Product No.	D	W	Weight	List Price
WORK-120-2436	24	36	46 lbs	\$699
WORK-120-2442	24	42	55 lbs	\$819
WORK-120-2448	24	48	64 lbs	\$843
WORK-120-3036	30	36	54 lbs	\$855
WORK-120-3042	30	42	65 lbs	\$867

Product No.	D	W	Weight	List Price
WORK-120-G1-2436	24	36	46 lbs	\$719
WORK-120-G1-2442	24	42	55 lbs	\$829
WORK-120-G1-2448	24	48	64 lbs	\$863
WORK-120-G1-3036	30	36	54 lbs	\$875
WORK-120-G1-3042	30	42	65 lbs	\$887

## Reverse Grain Worksurfaces for Returns and Bridges

A reverse grain (“RG”) worksurface allows for a consistent grain direction when used as a return in making an L-shaped desk or as a bridge in making a U-shaped desk – see examples below.

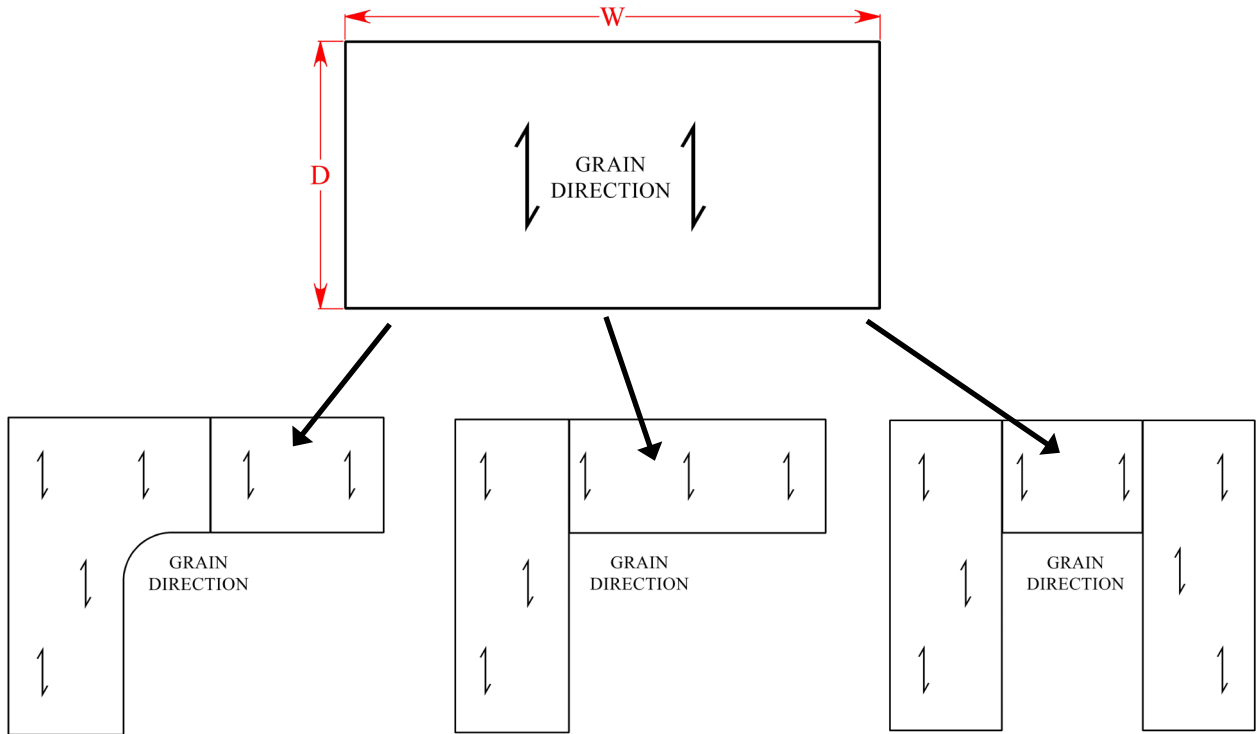

Extended corner with RG return

Rectangular surface with RG return

U-shaped desk with RG bridge

Product No.	D	W	Weight	List Price
WORK-RG-24d29w	24	29	22 lbs	\$238
WORK-RG-24d30w	24	30	23 lbs	\$239
WORK-RG-24d35w	24	35	27 lbs	\$247
WORK-RG-24d36w	24	36	28 lbs	\$248
WORK-RG-24d41w	24	41	31 lbs	\$251
WORK-RG-24d42w	24	42	32 lbs	\$252
WORK-RG-24d47w	24	47	36 lbs	\$256
WORK-RG-24d48w	24	48	37 lbs	\$257
WORK-RG-24d53w	24	53	41 lbs	\$313
WORK-RG-24d54w	24	54	41 lbs	\$314
WORK-RG-24d59w	24	59	45 lbs	\$318
WORK-RG-24d60w	24	60	46 lbs	\$319

Product No.	D	W	Weight	List Price
WORK-RG-30d29w	30	29	28 lbs	\$243
WORK-RG-30d35w	30	35	34 lbs	\$308
WORK-RG-30d36w	30	36	35 lbs	\$309
WORK-RG-30d41w	30	41	39 lbs	\$313
WORK-RG-30d42w	30	42	40 lbs	\$314
WORK-RG-30d47w	30	47	45 lbs	\$318
WORK-RG-30d48w	30	48	46 lbs	\$319
WORK-RG-30d53w	30	53	51 lbs	\$393
WORK-RG-30d54w	30	54	52 lbs	\$394
WORK-RG-30d59w	30	59	57 lbs	\$397
WORK-RG-30d60w	30	60	58 lbs	\$398

**One Grommet Hole:** To add a grommet hole, centered from left to right, include “-G1” after “WORK-RG” in the part number and add \$20 list – for example, WORK-RG-G1-24d60w. See page 3 for location information. Grommets are sold separately – see page 16.



## Accessories

### Anti-Sag Bars

Anti-sag bars provide cost-effective support for worksurfaces. Anti-sag bars are painted **black**. Screws are not included and are the responsibility of the installer.

Product No.	Description	List Price
ANTISAG-49	Support for surfaces 60" to 71" wide	\$58
ANTISAG-61	Support for surfaces 72" to 84" wide	\$70

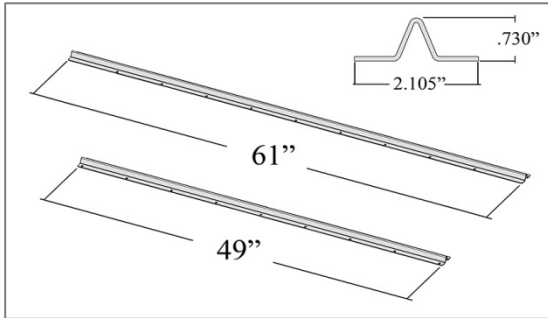

### Hat Channel Supports

Hat channels provide support for a worksurface (to prevent bowing) and a cavity for holding the controller and cords. Hat channel supports are painted **black**.

Product No.	Box Size	Pkg Wt	List Price
CLEHAT-39	41 x 7 x 3	8 lbs	\$82
CLEHAT-60	62 x 7 x 3	13 lbs	\$102



### Splice Plates

Made of heavy-gauge steel, splice plates are used to join two adjacent worksurfaces.

Product No.	Description	List Price
SPLICE PLATES	Kit of <u>two</u> worksurface ganging plates	\$43

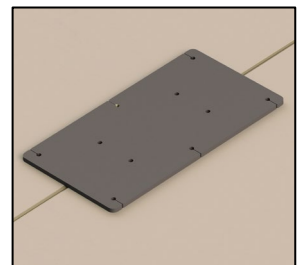

### Cord Grips for Wire Management

Cord grips hold all wire sizes with ease and provide an inexpensive tool for managing the underside of a worksurface. Cord grips are sold individually or in packages of 10. Attachment hardware is included.

Product No.	List Price
HATA-CORDGRIP1	\$18
HATA-CORDGRIP10	\$143

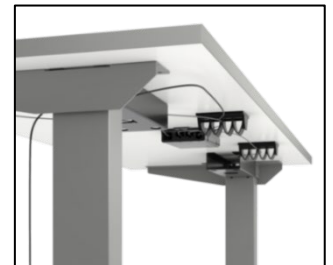
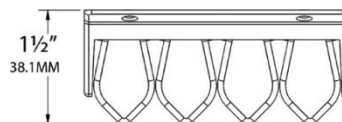

## J-Channel (Horizontal) Cord Minder

J-Channels provide a simple tool for hiding and managing cords.

- 48” long black plastic can be cut smaller in the field
- Secured with 2-sided tape (factory-installed)
- Sold individually or in cases of 50 pieces

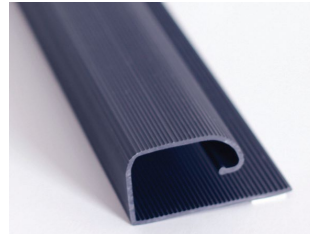
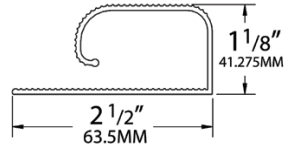

Product No.	Description	List Price
HATA-J48T-1	J-Channel Cord Minder, Single	\$36
HATA-J48T-50	J-Channel Cord Minder, Case of 50	\$1,330

## Vertebrae (Vertical) Cord Minder

Vertebrae cord minders provide an elegant means of managing cords from a worksurface to a power outlet on the floor or a wall. Each cord minder contains 50 links that can be modified to create fused, semi-flexible, or fully flexible joints. Each cord minder includes two magnetic pockets and a screw-in top connector.

Product No.	Color	List Price
HATA-VERT-BLK	Black	\$181
HATA-VERT-SLV	Silver	\$181
HATA-VERT-WHT	White	\$181



## Grommets

2-3/8” (60mm) grommets with built-in flexible tops, black or silver.

Product No.	List Price
HATA-GROMFX-BLK	\$16
HATA-GROMFX-SLV	\$16



## High Pressure Laminate Worksurface Warranty

- Twelve years

This warranty does not cover damage resulting from ordinary wear and tear, including finish changes and/or discoloration resulting from aging or exposure to light. In addition, this warranty does not cover heat-related damage, delamination or swelling from water damage, chemical damage, and damage resulting from improper installation or use of a product. Any material modification to the original product voids this warranty.

This warranty does not cover other manufacturers' products sold through Metal Arc. Rather, supplier warranties will apply to products not manufactured by Metal Arc.

TO THE EXTENT ALLOWED BY LAW, ANY IMPLIED WARRANTIES, INCLUDING ANY WARRANTY OF MERCHANTABILITY OR FITNESS FOR A PARTICULAR PURPOSE, ARE HEREBY DISCLAIMED.

This warranty does not cover, and Metal Arc shall not be liable for, incidental damages such as loss of time, loss of use, or inconvenience. In addition, this warranty does not cover, and Metal Arc shall not be liable for, any consequential damages (*e.g.*, the cost of fixing other property) caused by its products.

This warranty gives the purchaser specific legal rights. Purchasers may have other rights which vary from state to state or province to province.

**Contact Information:**

Metal Arc, Inc.  
3792 E. Ellis Rd.  
Muskegon, MI 49444  
PH: (231) 865-3111  
FAX: (231) 865-2037  
e-mail: [sales@metalarcinc.com](mailto:sales@metalarcinc.com)